

Instructions for Use

Vivaspin[®] Turbo 15 RC

Centrifugal Ultrafiltration Devices for Research Use

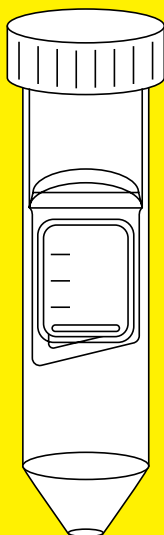

2563320-000-02



SARTORIUS

Contents

1	About these Instructions	5
1.1	Scope	5
1.2	Target Groups	5
1.3	Symbols Used	6
1.3.1	Warnings in Operation Descriptions	6
1.3.2	Other Symbols	6
2	Safety Instructions	7
2.1	General Functions	7
2.2	Personnel Qualification	7
2.3	Significance of these Instructions	8
2.4	Functionality of the Product	8
3	Product Description	9
3.1	Product Overview	9
3.2	Product Symbols	10
4	Process Preparation	11
4.1	Scope of Delivery	11
4.2	Unpacking	11
5	Operation	12
5.1	Pre-Rinsing the Product	12
5.2	Sanitizing the Product	12
5.3	Performing Filtration	13
5.3.1	Applying the sample	13
5.3.2	Inserting the Product into the Centrifuge	14
5.3.3	Performing Filtration	14
5.3.4	Removing the Sample	15
5.4	Desalting or Buffer Exchange	15
6	Storage	16
6.1	Storing the Product	16
7	Disposal	17
7.1	Decontaminating the Product	17
7.2	Disposing of the Product	17

8	Technical Specifications	18
8.1	Dimensions	18
8.2	Materials	18
8.3	Ambient Conditions	19
8.4	Operating Conditions	19
8.5	Equipment Required	20
8.5.1	Pipettes	20
8.5.2	Centrifuges	20
8.6	Sanitizing Methods	20
8.7	Chemical Compatibility	21
8.8	Typical Performance Characteristics	22
8.8.1	Typical Concentration Conditions	22
8.8.2	Examples of Times to Concentrate 30x at 20 °C and Solute Recoveries	23

1 About these Instructions

1.1 Scope

These instructions are part of the product. These instructions apply to the following versions of the product:

Vivaspin® Turbo 15 RC	Quantity	Prod. no.
5 kDa	12 48	VS15TR11 VS15TR12
10 kDa	12 48	VS15TR01 VS15TR02
30 kDa	12 48	VS15TR21 VS15TR22
50 kDa	12 48	VS15TR31 VS15TR32
100 kDa	12 48	VS15TR41 VS15TR42

1.2 Target Groups

The instructions are addressed to the following target groups. The target groups must possess the knowledge listed below.

Target Group	Knowledge and Qualifications
Operator	The operator is familiar with the device and the associated work processes. The operator understands the hazards which may arise when working with the device, and knows how to prevent them.

1.3 Symbols Used

1.3.1 Warnings in Operation Descriptions

NOTICE

Denotes a hazard that may result in property damage if it is **not** avoided.

1.3.2 Other Symbols

- ▶ Required action: Describes actions that must be carried out.
The actions in the sequence must be carried out in succession.
- ▷ Result: Describes the result of the actions carried out.

2 Safety Instructions

2.1 General Functions

The product is intended for the ultrafiltration and | or diafiltration of biological and aqueous solutions. The sample solutions and volumes used must be suitable for the product.

The filtration process must be carried out in a centrifuge. Macromolecules that are sufficiently larger than the nominal pore size of the membrane are retained above the membrane and progressively concentrated. The vertical membrane inhibits membrane fouling while the built-in dead stop impedes concentration to dryness and loss of sample.

The product is supplied non-sterile. It is intended for single use and must be disposed of after one use.

The product is intended exclusively for use in accordance with these instructions. Any further use beyond this is considered improper.

Operating Conditions for the Product

The product may only be used for research purposes. Do **not** use the product for *in vitro* diagnostic procedures or similar diagnostic procedures.

The product may only be used with the equipment and under the operating conditions described in the Technical Data section of these instructions.

2.2 Personnel Qualification

Persons without sufficient knowledge in the safe use of the device can injure themselves and others.

If a specific qualification is required for an activity: The target group is indicated. If no qualification is specified: The activity can be carried out by the target group "Operator".

2.3 Significance of these Instructions

Failure to follow the instructions might have serious consequences, e.g. danger to individuals.

- ▶ Read the instructions carefully and completely. The instructions for action build on each other.
- ▶ Ensure that the information contained in these instructions is available to all individuals working with the product.

2.4 Functionality of the Product

A damaged product or worn parts can lead to malfunctions or cause hazards which are difficult to identify.

- ▶ Only operate the product when it is safe and in perfect working order.

3 Product Description

3.1 Product Overview

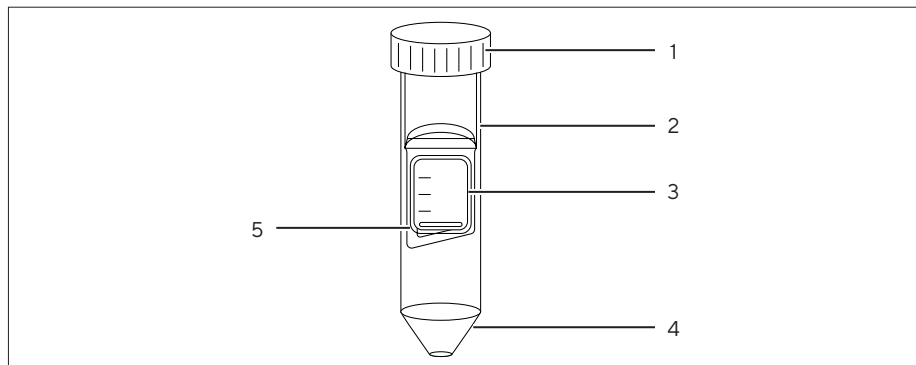









Fig.1: Product overview (example)

Pos.	Description
1	Concentrator cap
2	Concentrator
3	Twin vertical membranes
4	Filtrate container
5	Angular dead stop pocket

3.2 Product Symbols

Symbol	Description
	Catalogue number
	Batch code
	Use by
	Non-sterile product
For Research use only	Only suitable for research purposes
	Do not re-use
	Consult instructions for use
	Temperature limits

4 Process Preparation

4.1 Scope of Delivery

Article	Quantity
Product, packed in a cardboard box	12 or 48
Instructions for Use	1

4.2 Unpacking

Procedure

- ▶ **NOTICE** Risk of product malfunctions due to exceeding the usability!
Check the usability of the product (see specification on packaging).
Dispose of products for which the usability has been exceeded.
- ▶ Unpack the product.

5 Operation

5.1 Pre-Rinsing the Product

Membranes in the product may contain traces of glycerin. If this substance can interfere with the analysis of the sample: The membranes may be rinsed before filtration.

Procedure

- ▶ Remove the concentrator cap.
- ▶ Use a pipette to apply a filling volume of buffer solution or deionized water into the concentrator.
- ▶ Replace the concentrator cap.
- ▶ Wash the buffer solution or deionized water through the membranes by centrifugation.
- ▶ Empty the concentrator and filtrate container.
- ▶ If the pre-rinsed product is not used immediately: Cover the surface of the membranes with buffer solution or water and store the product in the refrigerator. The membranes must not dry out.

5.2 Sanitizing the Product

The product can be sanitized before use. The sanitizing method must be suitable for the product (see Chapter 8.4, page 19).

Procedure

- ▶ Remove the concentrator cap.
- ▶ Sanitize the product using the desired sanitizing method.
- ▶ Empty the product.

5.3 Performing Filtration

5.3.1 Applying the sample

It is recommended that a pipette is used to apply the sample into the product. The pipette must be compatible with the product (see Chapter "8.5.1 Pipettes", page 20).

Please ensure that the molecular weight cut-off (MWCO) of the product is suitable for the size of the target molecule to be concentrated. In order to ensure maximum recovery of the target molecule, Sartorius recommends selecting a MWCO that is at least 50% below the size of the target molecule.

NOTICE

Risk of product malfunctions due to using unsuitable samples!

- ▶ Only pour suitable samples into the product (see Chapter "8.7 Chemical Compatibility", page 21).

NOTICE

Risk of product malfunctions or damage to the centrifuge due to exceeding the maximum filling volume!

- ▶ Do **not** exceed the maximum filling volume (see Chapter "8.4 Operating Conditions", page 19).

Procedure

- ▶ Check whether the MWCO of the product is suitable for the application.
- ▶ Remove the concentrator cap.
- ▶ Apply the sample into the product using a pipette. Comply with the maximum filling volume.
- ▶ Replace the concentrator cap.

5.3.2 Inserting the Product into the Centrifuge

Procedure

- ▶ **NOTICE** Risk of product malfunctions or damage to the centrifuge! Only use the product in suitable centrifuges (see Chapter “8.5.2 Centrifuges”, page 20).
- ▶ Insert the product into the centrifuge.
- ▶ If a centrifuge with fixed-angle rotor is used: Place the product into the centrifuge as follows:
 - The printed volume graduations on the concentrator (1) are facing sideways.
 - The dead stop pocket of the concentrator (2) is pointing towards the outside of the fixed-angle rotor.

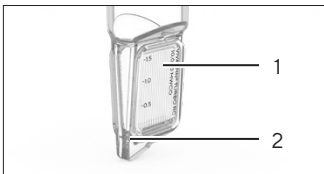

5.3.3 Performing Filtration

Procedure

- ▶ **NOTICE** Risk of product malfunctions or damage to the centrifuge. Comply with the approved centrifugation limit values (see Chapter “8.4 Operating Conditions”, page 19).
- ▶ Centrifuge the product in the centrifuge until the desired concentration level is achieved.

5.3.4 Removing the Sample

Procedure

- ▶ If the filtration or concentration is complete: Remove the product from the centrifuge.
- ▶ Remove the concentrator cap.
- ▶ Recover the sample from dead stop pocket of the concentrator using a pipette.
- ▶ If the membrane was pre-rinsed before filtration: Decant the filtrate and concentrate.

5.4 Desalting or Buffer Exchange

Procedure

- ▶ Concentrate the sample to the desired level.
- ▶ Remove the concentrator cap.
- ▶ Discard the filtrate.
- ▶ Refill the concentrator with an appropriate exchange buffer.
- ▶ Concentrate the sample again.
- ▶ Repeat the process until the original buffer and | or contaminating micro-solute has been sufficiently removed.
- ▶ If the desalting or buffer exchange is complete: Recover the sample.

6 Storage

6.1 Storing the Product

If the product has been unpacked and the membranes have been pre-rinsed: The membranes must be protected against drying out. For this purpose, the membranes must be stored in a moist and cool condition.

NOTICE

Risk of damage to the product due to improper storage!

- ▶ Comply with the storage specifications.
-

Procedure

- ▶ If the product is packaged: Store the product in the packaging.
- ▶ If the product has been unpacked and the membranes have been pre-rinsed:
 - ▶ Remove the concentrator cap.
 - ▶ Cover the membranes with buffer solution or water.
 - ▶ Replace the concentrator cap.
- ▶ Store the product according to the ambient conditions (see Chapter 8.3, page 19).

7 Disposal

7.1 Decontaminating the Product

If the product has come into contact with hazardous substances: Steps must be taken to ensure proper decontamination and declaration. The operator of the product is responsible for adhering to local government regulations on the proper decontamination and declaration for transport and disposal.

Procedure

- ▶ If the product has come into contact with hazardous substances: Decontaminate the product.

7.2 Disposing of the Product

The product must be disposed of properly. The packaging is made of environmentally friendly materials that can be used as secondary raw materials.

Requirements

The product must be decontaminated.

Procedure

- ▶ Dispose of the product in accordance with local government regulations.
- ▶ Dispose of the packaging in accordance with local government regulations.

8 Technical Specifications

8.1 Dimensions

	Unit	Value
Length x Diameter	mm	118 x 30
Active membrane surface	cm ²	8.6
Weight	g	25

8.2 Materials

	Materials
Concentrator	Styrene butadiene copolymer (SBC)
Concentrator cap Filtrate container	Polypropylene
Membranes	Regenerated cellulose

8.3 Ambient Conditions

	Unit	Value
Storage temperature		
When packed	°C	+4 - +40
When unpacked, with membrane kept moist	°C	+2 - +8

8.4 Operating Conditions

	Unit	Centrifuge with swing bucket rotor	Centrifuge with fixed-angle rotor (25°)
For use with centrifuge			
Filling volume, minimum	mL	4	4
Filling volume, maximum	mL	15	11
Membrane hold-up volume, minimum	µL	28	28
Dead stop volume ¹	µL	120	140
Relative Centrifugal Force, maximum			
5 - 50 kDa	<i>g</i>	4,000	6,000
100 kDa	<i>g</i>	3,000	6,000

¹The dead stop volume may vary depending on the type and concentration of the sample, operating temperature and | or centrifuge rotor

8.5 Equipment Required

8.5.1 Pipettes

Pasteur pipette, variable volume or fixed volume pipette for sample application and concentrate or filtrate retrieval

8.5.2 Centrifuges

	Unit	Value
Swing bucket rotor or fixed-angle rotor		
Minimum rotor angle for fixed-angle rotor		25°
Rotor suitable for centrifuge tubes with the following properties		
Conical base		
Volume	mL	50
Diameter	mm	30

8.6 Sanitizing Methods

Rinsing with 70% ethanol solution or with sanitizing gas mixture, e.g. ethylene oxide

Not suitable for autoclaving

8.7 Chemical Compatibility

Chemical, biological and aqueous solutions with appropriate compatibility for the materials of the product (2 hr contact time)

Examples of compatible chemical solutions

Acetic Acid (25%)	Lactic Acid (5%)
Acetonitrile (10%)	Mercaptoethanol (10 mM)
Ammonium Sulphate (saturated)	Methanol (60%)
N-Butanol (70%)	Phosphate Buffer (1 M)
Dimethyl Sulfoxide (5%)	Polyethylene Glycol (10%)
Ethanol (70%)	Sodium Deoxycholate (5%)
Formic Acid (5%)	Sodium Dodecylsulfate (0.1 M)
Glycerine (70%)	Sulfamic Acid (3%)
Guanidine HCl (6 M)	Triton®* X-100 (0.1%)
Imidazole (500 mM)	Urea (8%)
Isopropanol (70%)	

* Triton® is a registered trademark of Union Carbide Corp.

8.8 Typical Performance Characteristics

8.8.1 Typical Concentration Conditions

		Centrifuge with swing bucket rotor	Centrifuge with fixed-angle rotor
	Unit	Value	Value
Centrifugation for recovery of > 90% of the dissolved substance (typical)			
Concentration times	Min	5 – 20	5 – 20
Concentration factor	Cf	30x	30x
Buffer exchange and centrifugation for reducing 99% of the dissolved salts	Number	3	3

8.8.2 Examples of Times to Concentrate 30x at 20 °C and Solute Recoveries

	Centrifuge with swing bucket rotor		Centrifuge with fixed-angle rotor (25°)	
	Time (min)	Solute Recovery	Time (min)	Solute Recovery
Lysozyme 1 mg/mL (14.3 kDa MW)				
5 kDa	23	94%	37	92%
Cytochrome c 0.25 mg/mL (12.4 kDa MW)				
5 kDa	25	87%	37	89%
α-Chymotrypsin 1 mg/mL (25 kDa MW)				
10 kDa	7	93%	9	92%
BSA 1 mg/mL* (66 kDa MW)				
10 kDa	8	94%	10	98%
30 kDa	4	96%	4	93%
IgG 1 mg/mL (160 kDa MW)				
50 kDa	17	95%	11	96%
100 kDa	18	89%	12	89%

* 0.25 mg/mL for 30 kDa MWCO

Sartorius Stedim Lab Ltd.
Sperry Way, Stonehouse
GL10 3UT, UK

Phone: +44 1453 821972
www.sartorius.com

The information and figures contained in these instructions correspond to the version date specified below.

Sartorius reserves the right to make changes to the technology, features, specifications and design of the equipment without notice.

Masculine or feminine forms are used to facilitate legibility in these instructions and always simultaneously denote all genders.

Copyright notice:

These instructions, including all components, are protected by copyright.

Any use beyond the limits of the copyright law is not permitted without our approval.

This applies in particular to reprinting, translation and editing irrespective of the type of media used.

Last updated:
09 | 2022